

















ELEKTROINŠTALAČNÁ KRABICA

ŠROBOVACIE VEKO - IP55 
100x100 - 120x80 - 150x110 - 190x145

Technický list

Smernica	LVD 2014/35/EU					
Normy Dodatky	EN 60670-1:2005+A1:2013 Krabice a kryty, elektrické inštalácie EN EN 60670-22:2006 Krabice a kryty, osobitné požiadavky EN 60529 Stupeň ochrany, kryty, hodnota IP					
V súlade s RoHS	2022/95/ES Obmedzenie nebezpečných látok, RoHS					
Aplikovanie	Interiér – Exteriér - Rezidenčný – Industriálny Plastová spojovacia krabica so skrutkovacím vekom - plastové skrutky Zapojenie, prepojenie alebo predĺženie S ohybnými priechodkami, vstupmi pre príslušenstvo - rúry - káble				 	
Inštalácie	Odkryté – na stenu Elektroinštalácia, napájanie, osvetlenie, automatizácia, telekomunikácie, CCTV				 	
Materiál	Polyvinylchlorid > U-PVC					
Charakteristika	IP Rate	Pevné	5	Kvapalné	5	
	Glow Wire Test	850 °C				
	Odolnosť - UV	R				
	Odolnosť - chemikálie	R				
	Odolnosť - Oheň	FR-SE				
	Dielektrická pevnosť	400V				
	Teplotná stabilita:	-15 °C		+60 °C		
Farba.1	šedá RAL7035	Farba.2	Biela			

ELEKTROINŠTALAČNÁ KRABICA

Šrobovacie veko - IP55



TYP	100x100 PS/ G	100x100 PS/ W
Kód	32-21009-100	32-21024-100
A _mm	105	105
B _mm	50	50
D Rúra OD Ø _mm	16/20/25	16/20/25
E Vstupy Ø _mm	29	29
Farba	Šedá	Biela
Balenie / ks	60	60

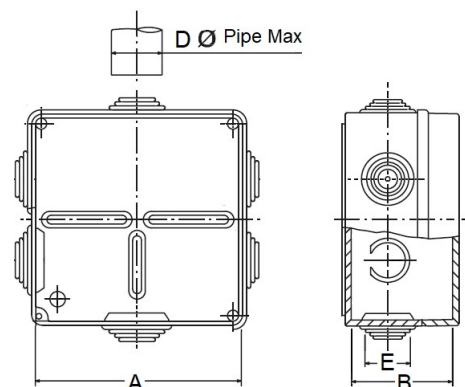

TYP	120x80
Kód	32-21006-120
A _mm	120
B / mm	80
C / mm	50
D Rúra OD Ø _mm	16/20/25
E Vstupy Ø _mm	29
Farba	Šedá
Balenie / ks	50

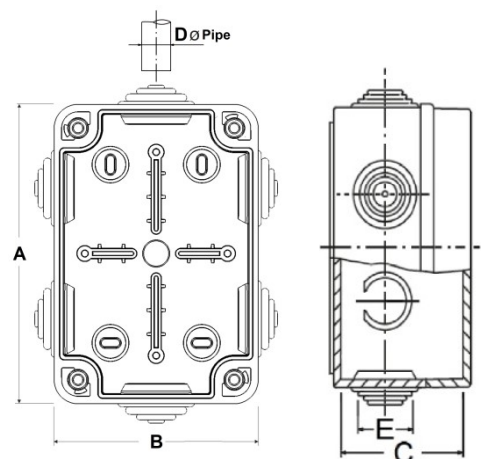

TYP	150x110	190x145
Kód	32-21007-150	32-21008-190
A _mm	150	190
B / mm	110	145
C / mm	70	70
D Rúra OD Ø _mm	16/20/25	16/20/25/32
E Vstupy Ø _mm	29	37
Farba	Šedá	Blela
Balenie / ks	24	24

